

Next Generation Tools By



TCT
BAND SAW
BLADE

New Edge of Technology
DIAMOND
TECHNOLOGY

Awe-inspiring
Precision &
Performance

BRAZE - REPLACEABLE - PCD
Wood Working Tools

The Sign Of Excellence

Next Generation Tools By



The Company, Yash Tooling System is setting new Benchmarks in tools' designing, manufacturing and overall quality operations. With introduction of these tools with Replaceable Knives, Yash now has the distinction of being the first Indian company to undertake manufacturing of such international quality products. In the late nineties, Brazed tools market was teeming with various manufacturers, yash though being late entrant – acquired a position of premium brand very quickly. Still the quality brazed tools users always prefer Yash over any other product. Yash uses the best European machinery & processes to manufacture its products, with highest quality raw material. In short, Brazed or Replaceable, Yash tools are powered to give unbeatable performance and a long – long working life.

To win the markets, you have to do something extra – ordinary. Yash helps you achieve that. Your wood-work and panel jobs can be crafted so meticulously and consistently qualitatively that your product stand apart from the crowd, making you a winner of the customer choice. Yash Symbolises ultimate quality. Such highly dependable and systematically precision tools, till now were possible with imported brands only. Now you have it here in 'Yash', that too at comparably lower cost and with reliable supply and service support.

INNOVATIVE TOOLS FOR WOOD WORKING INDUSTRIES

Our In House Machine Facility

For

ENHANCE QUALITY | BETTER PERFORMANCE | UN BEATABLE PRICE
FASTEST DELIVERY | AFTER SALES & SERVICE



PCD Grinding



CNC Balancing Machine



Profile Grinding



CNC Profile Grinding



Induction Brazing



CNC Vertical Milling



CNC Turning

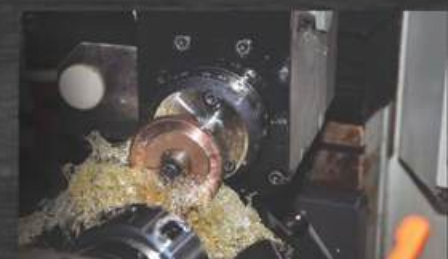

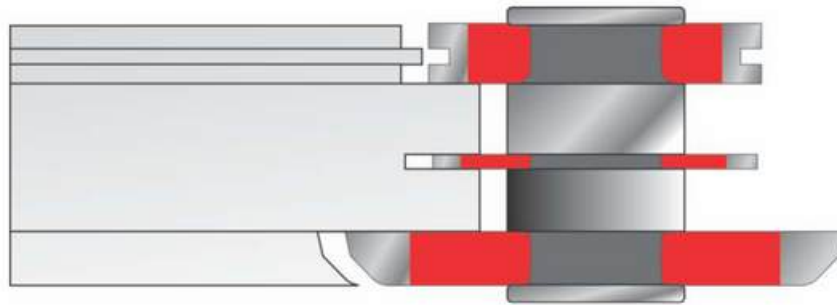

Technical Details :

upvc end milling machine

Application :

This cutter is used for perfect joining frames of windows and doors

Simta U PVC Casement Mullion **YTB 77 101**

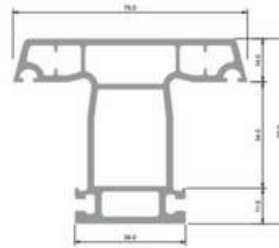

Kaka UPVC Casement Mullion **YTB 77 102**

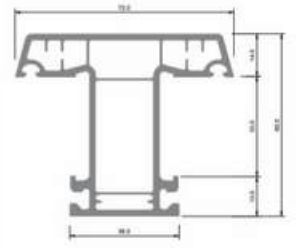

PSP UPVC Casement Mullion **YTB 77 103**

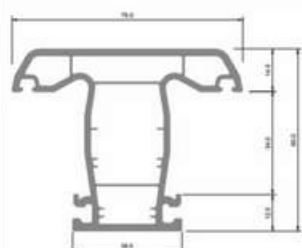

Prominace UPVC Casement Mullion **YTB 77 104**

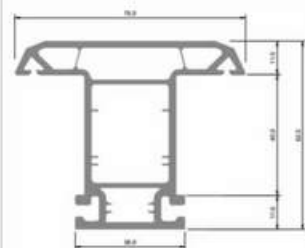

Prominace UPVC Casement Mullion **YTB 77 105**

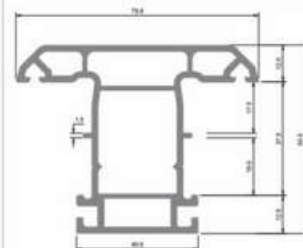

Simta UPVC Sliding & Casement Mullion **YTB 77 106**

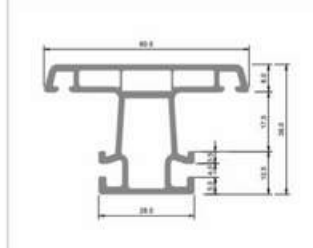

Kaka UPVC Sliding & Casement Mullion **YTB 77 107**

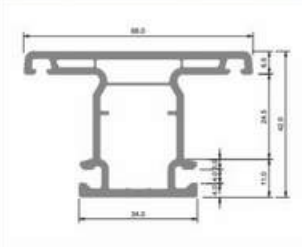

Prominace UPVC Sliding & Casement Mullion **YTB 77 108**

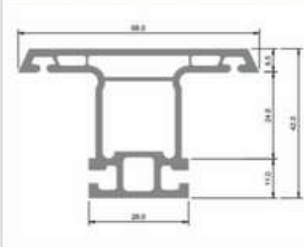

JPI UPVC Sliding & Casement Mullion **YTB 77 109**

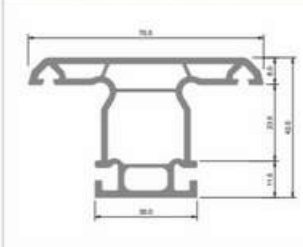

Prominace UPVC Sliding & Casement Mullion **YTB 77 110**

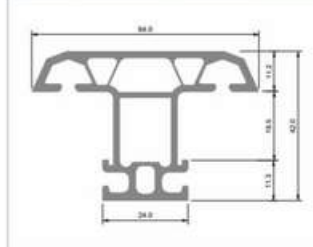

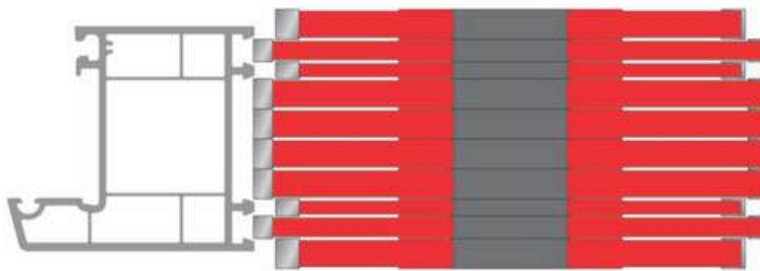
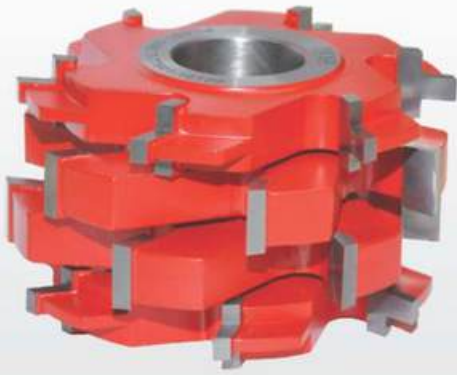

Technical Details :
upvc end milling machine

Application :
Upvc Door Window Corner Cleaning Portable Tools It is used for clean the surface welding seam of PVC/UPVC/plastic/vinyl window. door.

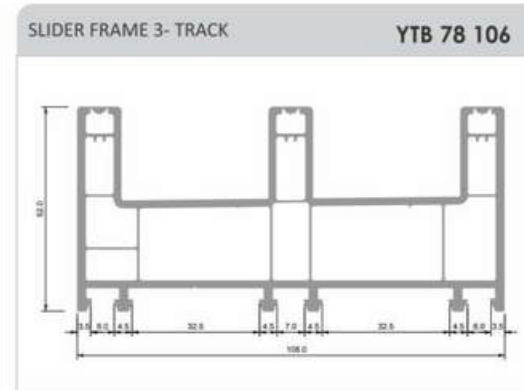
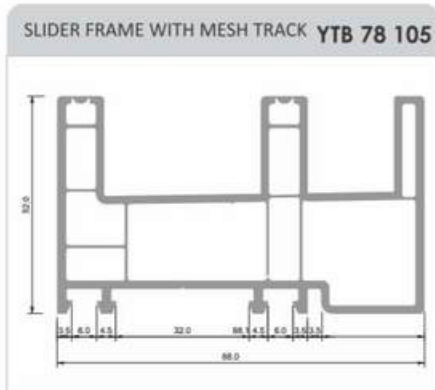
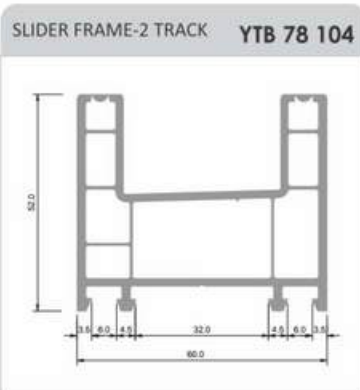
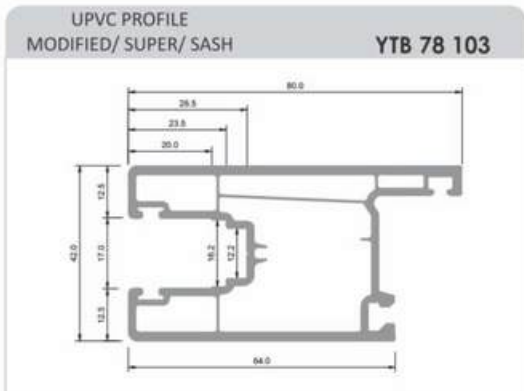
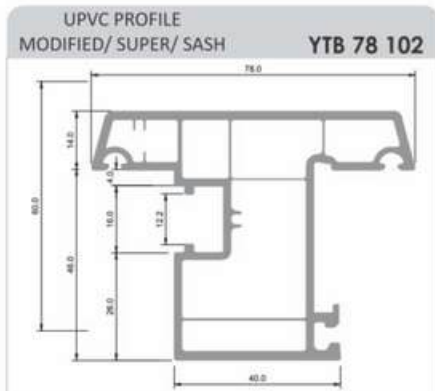
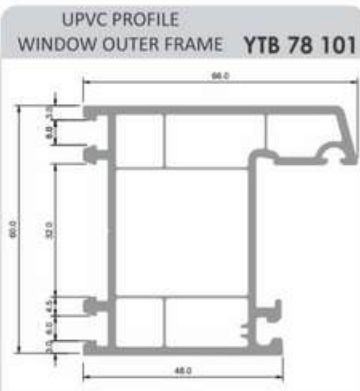

Crusher Cutter For PVC- YTB 79



YTB 79

| ORDER CODE | DIA | THICK | BORE | Z | KEYWAY |
|------------|-----|-------|------|----|---------|
| YTB 79 101 | 259 | 19.5 | 120 | 12 | 20 X 10 |



Saw Blade for UPVC & Aluminum



Solid Carbide Single Flute Endmill For UPVC-

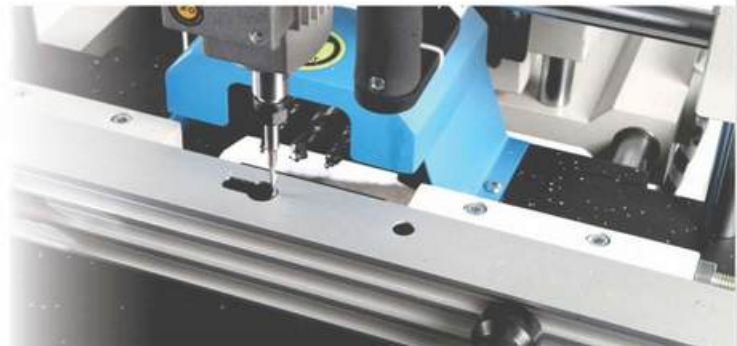

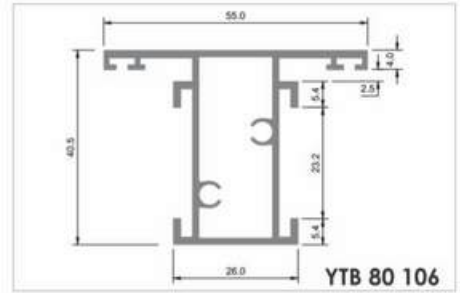
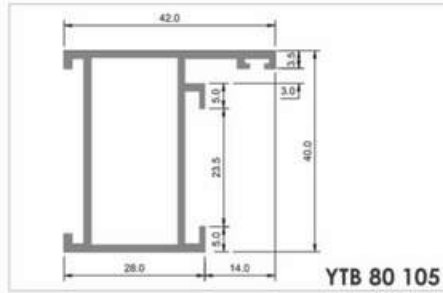
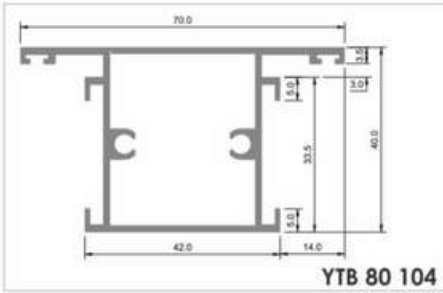
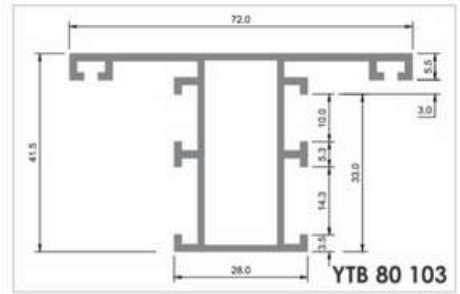
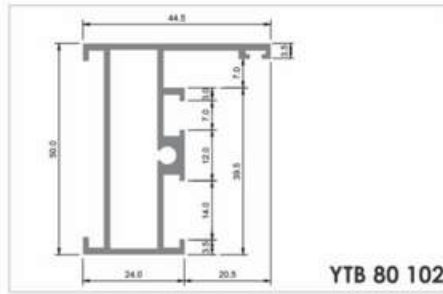
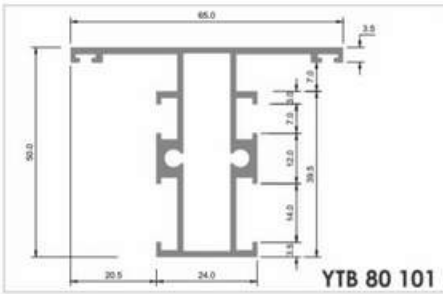
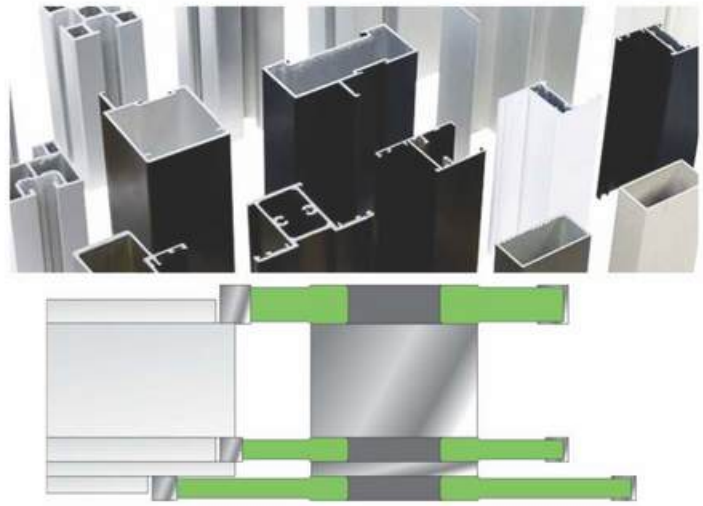

Hole Saw Bits for Aluminum Section

Solid Carbide Single Lip

Aluminum Endmill Four Flute



HSS Aluminum END MILL



Any Customized Specifications Also Can Make As Per Requirements

New **Technology**
One **Quality**
One **Name**

Next Generation Tools By



YASH TOOLING SYSTEM

Plot No.: 462, Road No.: 12, Kathwada G. I. D. C., Odhav, Ahmedabad – 382430, Gujarat, INDIA
Phone : +91 9925430880 , 8000630880, 9925412341 **Email** : yashtoolingsystems@gmail.com